



- Zwei Designformen: Tulip und Pagode
- Feste Installation
- Membran und Konstruktion sind nicht faltbar
- Windsicher bis zu 100 km/h

#### Größen

3x3m / 4x4m / 4.5x4.5m / 5x5m

Ø 3m / Ø 4m / Ø 5m / Ø 6m



## SHADE STRUCTURE

Neues Produktdesign wird durch Materialverarbeitungstechnik entwickelt: Außergewöhnliche Inversion erreicht der Shade Structure durch die MDT-eigene Schweißklebetechnik, die den PVC-Bezug fixiert und maximale Robustheit gewährleistet. Der Schirm ist nur für die Installation an einem festen Standort konzipiert. Die außergewöhnliche Form des Schirms versieht jede Location mit einer besonderen Note.

- Nicht faltbar

# SHADE STRUCTURE TULIP TYP SHT

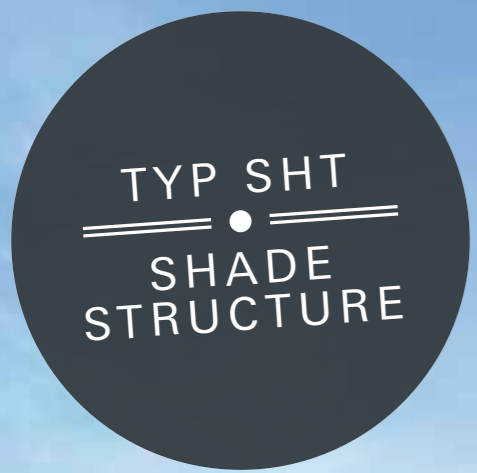

### GESTELL

Gestell aus Stahl inkl. Adapter, innenliegender Wasserablauf, fest installierte Konstruktion, Querverstrebungen vom Mast aus als Stabilitätskreuz, Gestell pulverbeschichtet (Polyesterpulver, ca. 80 µ).

- In jeder RAL-Farbe erhältlich
- Schirm ist nicht faltbar.

### MECHANIK

Stahlseile zum Nachspannen der Membran.

### BEZUG

PVC, geschweißt, Farbe Weißgrau



Rund      Quadratisch      Krone      Streben      Handkurbel

## VERANKERUNGEN





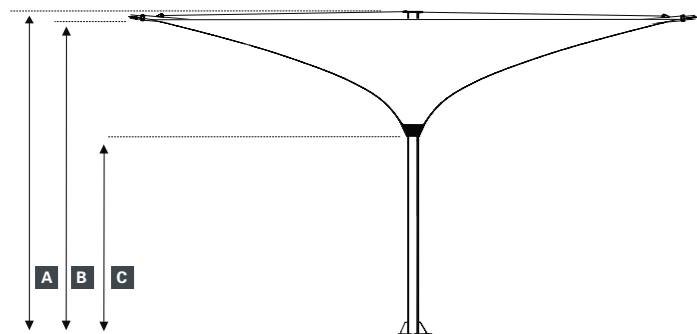

Rahmenständer







- ENTWÄSSERUNG DURCH DEN MITTELMAST  
- ANSCHLUSS AN DIE KANALISATION DURCH ROHRBOGEN IM FUNDAMENT (BAUSEITS)

**GRÖSSE IN M**





\*alle Maßangaben ca.

|                              |  |  |  |  |
|------------------------------|---|---|---|--|
|                              | <b>3x3</b>  | <b>4x4</b>  | <b>4,5x4,5</b>  | <b>5x5</b>   |
| <b>GEWICHT</b>               |   |   |   |  |
| Schirm ohne Verpackung in kg | 259   | 210   | 277   | 250  |
| Gestell in kg                | 250   | 198   | 262   | 232  |
| Bezug in kg                  | 9   | 12  | 15  | 18   |





**GEÖFFNETER SCHIRM TULPE**

|   |  |  |  |  |
|---|---|---|---|--|
|   | <b>Ø3</b>   | <b>Ø4</b>   | <b>Ø5</b>   | <b>Ø6</b>  |
| <b>A</b> Höhe in cm                       | 404   | 325   | 340   | 340  |
| <b>B</b> Bodenfreiheit bis Membran in cm  | 335   | 320   | 317   | 320  |
| <b>C</b> Bodenfreiheit bis Trichter in cm | 203   | 198   | 198   | 198  |

**GEWICHT**

|                              |  |  |  |  |
|------------------------------|---|---|---|--|
|                              | <b>Ø3</b>   | <b>Ø4</b>   | <b>Ø5</b>   | <b>Ø6</b>  |
| Schirm ohne Verpackung in kg | 235   | 308   | 329   | 421  |
| Gestell in kg                | 230   | 298   | 314   | 400  |
| Bezug in kg                  | 5   | 10  | 15  | 21   |

**GEÖFFNETER SCHIRM PAGODE**

|   |  |  |  |  |
|---|---|---|---|--|
|   | <b>Ø3</b>   | <b>Ø4</b>   | <b>Ø5</b>   | <b>Ø6</b>  |
| <b>A</b> Höhe in cm                       | 404   | 347   | 352   | 362  |
| <b>B</b> Bodenfreiheit bis Membran in cm  | 335   | 326   | 331   | 337  |
| <b>C</b> Bodenfreiheit bis Trichter in cm | 203   | 204   | 204   | 204  |

Lieferung erfolgt auf Palette

alle Größen- und Gewichtsangaben sind Annäherungen

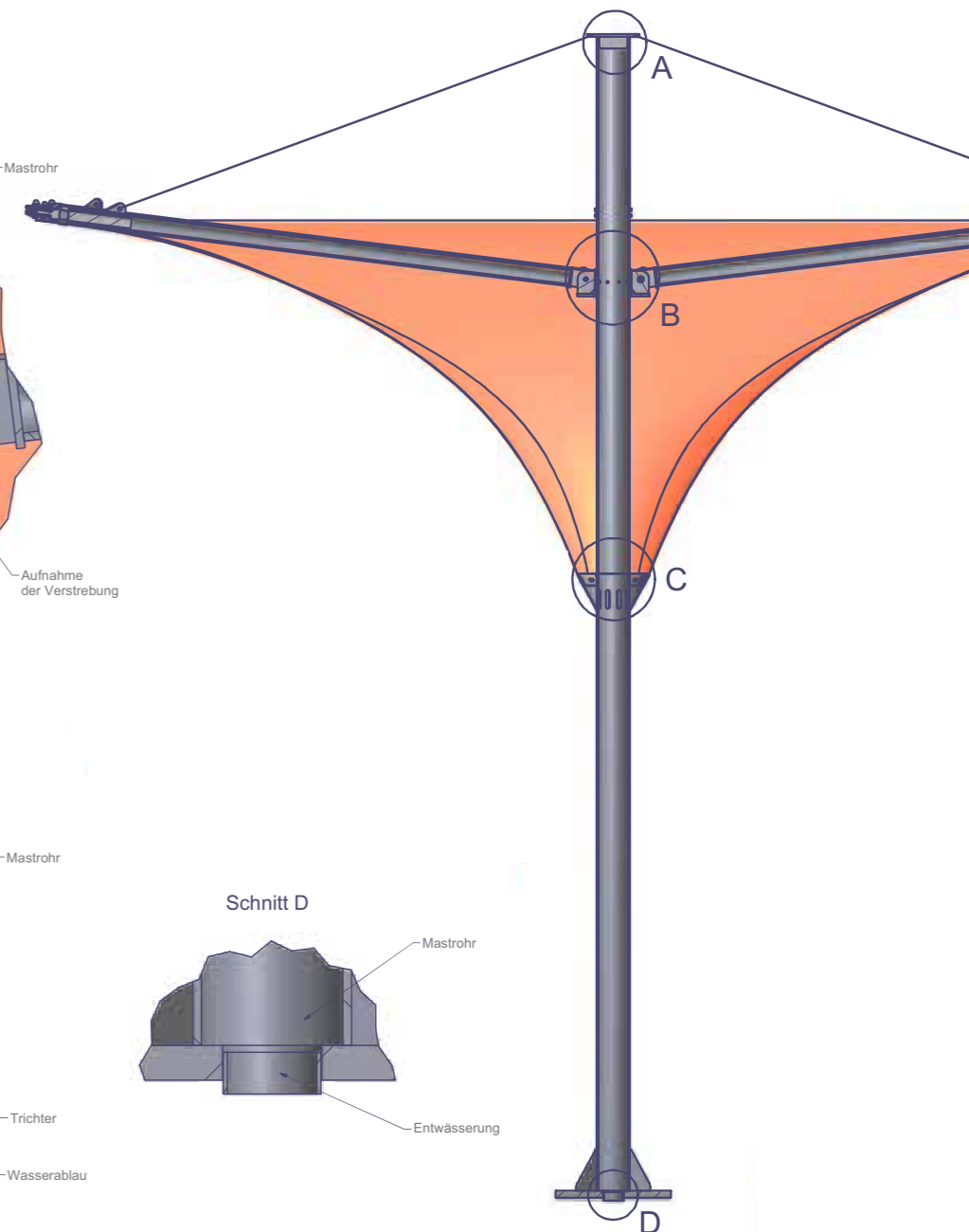
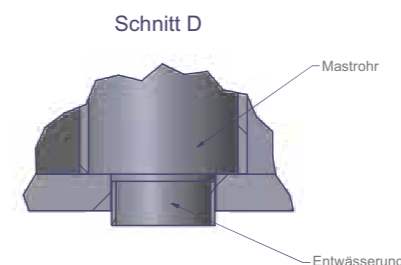
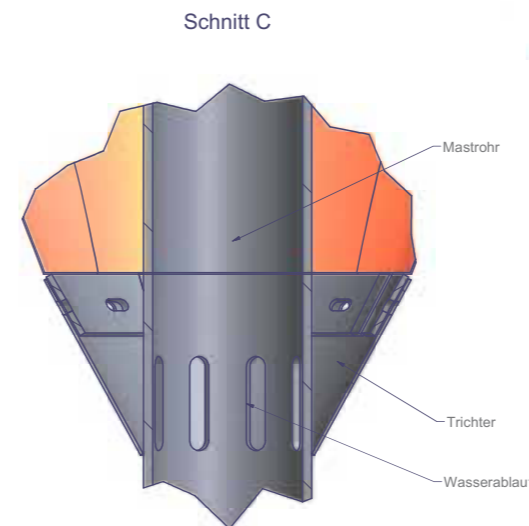
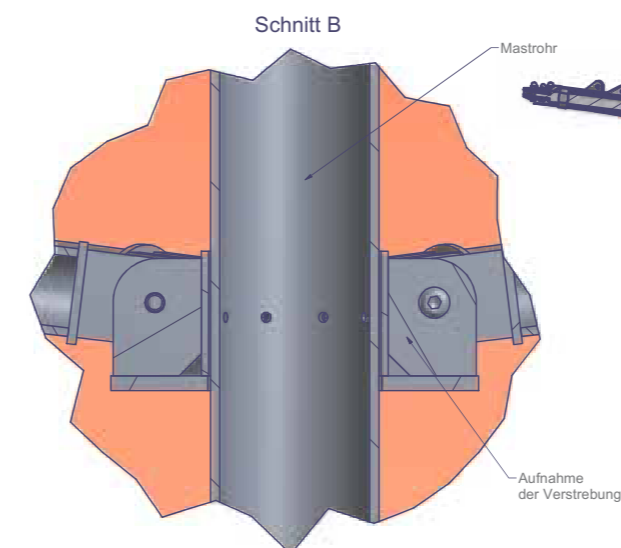
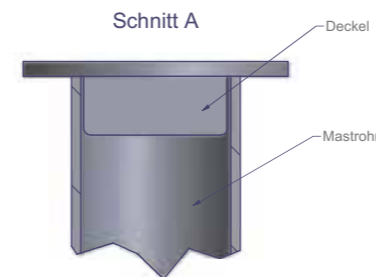

STOFFE, FARBEN



MDT-tex®-680 PVC

Für alle Dimensionen.  
Für alle Schirmtypen.

- 01: M 00-FR weiß
- 02: M 61-FR silber
- 03: M 21-FR beige
- 04: M 11-FR gelb
- 05: M 31-FR rot
- 06: M 35-FR bordeaux
- 07: M 41-FR grün
- 08: M 42-FR dunkelgrün
- 09: M 52-FR marineblau
- 10: M 81-FR anthrazit
- 11: M 91-FR schwarz

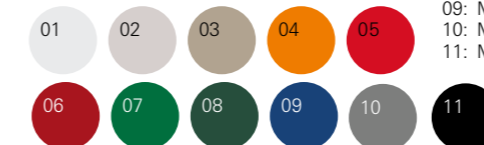

Membran und Konstruktion sind nicht faltbar